

歡迎使用全新的Sony IC錄音機！

這是一份提供IC錄音機基礎操作說明的快速入門指南。請仔細閱讀。我們希望您會喜愛使用這台全新的Sony IC錄音機。

請檢查附件項目。

- IC錄音機 (1)
- 立體聲耳機\* (1)
- 便攜袋\* (1)
- LR03 (AAA型) 鹼性電池 (2)
- 快速入門指南
- 應用程式軟體、Sound Organizer (安裝程式檔案已儲存在內建記憶體中，以便安裝在電腦上。)
- 說明指南 (HTML 檔案已儲存在內建記憶體中，以便複製到電腦上。)
- \* 隨附於某些地區型號。

選購附件

- 電容式麥克風ECM-TL3、ECM-CS3
- NH-AAA-B2EN、NH-AAA-B2KN充電電池
- USB交流電轉換器AC-U50AG
- 簡易充電器與兩類AAA多用途頂級電池BCG-34HS2KAN、BCG-34HW2KAN

註

部分型號或選購件未在有些國家或地區上市。

零件與控制按鈕

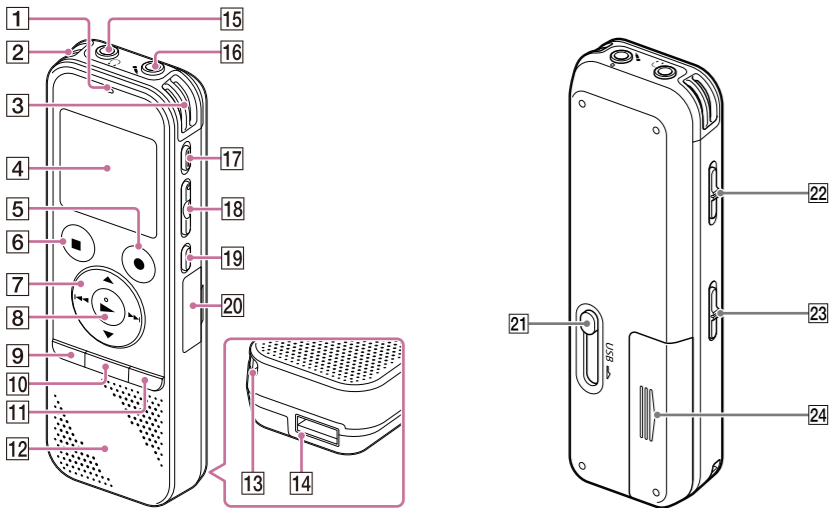

- 1 操作指示燈
- 2 內建麥克風 (立體聲) (左)
- 3 內建麥克風 (立體聲) (右)
- 4 顯示視窗
- 5 ●REC/PAUSE (錄音/暫停) 按鈕
- 6 ■STOP按鈕
- 7 控制按鈕 (▲、▼、◀▶ (倒帶/快倒)、▶▶ (提示/快進))
- 8 ▶▶ (播放/輸入) 按鈕\*1
- 9 MENU按鈕
- 10 T-MARK (曲目標記) 按鈕
- 11 FOLDER按鈕
- 12 喇叭
- 13 腕帶孔 (腕帶不提供。)
- 14 USB接頭槽
- 15 耳機插孔
- 16 (麥克風) (PLUG IN POWER) 插孔\*1
- 17 ERASE按鈕
- 18 VOL +/- (音量 +/-) 按鈕\*1
- 19 A-B (A-B重播) 按鈕
- 20 M2/microSD記憶卡插槽 (記憶卡插槽位在保護蓋內。)\*2
- 21 USB滑杆
- 22 HOLD+POWER ON/OFF開關
- 23 DPC (SPEED CTRL) 開關
- 24 電池匣

\*1 這些按鈕和插孔有一個觸點。可將其用作操作的基準點，或用於識別各個端子。  
\*2 在本快速入門指南中，M2/microSD記憶卡統稱為“記憶卡”。M2/microSD記憶卡插槽則稱為“記憶卡插槽”。

讓我們來試用的新IC錄音機

1. 開啟電源。

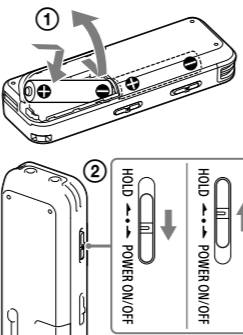

- 1 滑動並拉開電池匣蓋，接著按照正確極性插入LR03 (AAA型) 鹼性電池。
- 2 打開電源。  
開啟電源  
依“POWER ON/OFF”方向滑動並按住 HOLD+POWER ON/OFF 開關，直到視窗顯示出現為止。  
防止意外操作 (HOLD)  
依“HOLD”方向滑動 HOLD+POWER ON/OFF 開關。  
若要解除IC錄音機的HOLD狀態，請將HOLD POWER ON/OFF開關滑向中央。

2. 設定日期和時間。

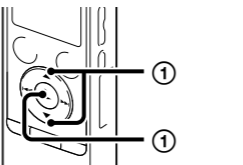

- 1 按▲或▼設定年份 (年份的最後兩位數)，然後按▶ (播放/輸入)。重複此步驟，以依序設定月、日、時和分。  
設定分鐘並按▶ (播放/輸入) 後，時鐘便會反映設定。  
您可以稍後設定時鐘。如需詳細資料，請參閱IC錄音機的說明指南。

3. 選擇選單語言。

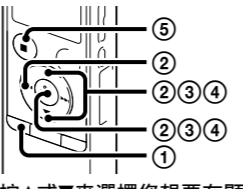

- 1 按MENU。
- 2 按◀◀，按▲或▼來選擇，然後按▶ (播放/輸入)。
- 3 按▲或▼來選擇“Language”，然後按▶ (播放/輸入)。
- 4 按▲或▼來選擇您想要在顯示視窗中使用的語言，然後按▶ (播放/輸入)。可選擇以下語言：(\* 預設設定。)  
• 位在美國和拉丁美洲國家/地區  
English (英語)、Español (西班牙語)、Français (法語)  
• 位在其他國家/地區  
Deutsch (德語)、English (英語)\*、Español (西班牙語)、Français (法語)、Italiano (意大利語)、Русский (俄語)、한국어 (韓語)、繁體中文、簡體中文 (簡體中文)、ไทย (泰語)
- 5 按■STOP。

4. 錄音。

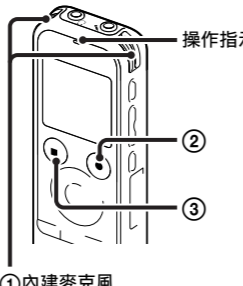

- 在您開始使用IC錄音機前，請務必將HOLD+POWER ON/OFF開關滑向中央，以解除HOLD狀態。
- 1 放置IC錄音機時，請將內建麥克風朝向錄音來源。
- 2 按●REC/PAUSE。錄音開始，操作指示燈亮起紅色。  
可按●REC/PAUSE以暫停錄音。再次按●REC/PAUSE以重新開始錄音。
- 3 按■STOP停止錄音。畫面顯示“Accessing...”動畫且錄音隨即停止。

5. 聆聽。

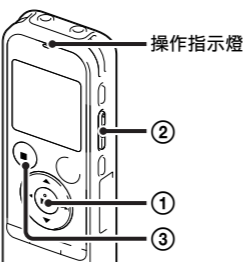

- 如果沒有選擇檔案，則會播放剛才錄製的檔案，或是最近播放的檔案。如需選擇檔案的詳細資料，請參閱IC錄音機的說明指南。
- 1 按▶ (播放/輸入)。開始播放，操作指示燈亮起綠色。
- 2 按VOL +/-來調整音量。
- 3 按■STOP停止播放。

6. 清除。

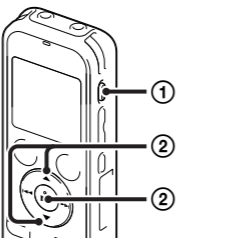

- 檔案一旦清除，便無法復原。
- 1 按ERASE。畫面顯示“Erase?”，隨即播放要清除的檔案供您確認。
- 2 使用▲或▼選擇“Execute”，然後按▶ (播放/輸入)。畫面顯示“Erasing...”，隨即清除選擇的檔案。

搭配電腦使用

將說明指南安裝在電腦上

您可以將IC錄音機內建記憶體中的說明指南安裝在電腦上，藉此搜尋詳細的操作資訊，以及當發生問題時可行的解決方案。

- 1 滑動IC錄音機背面的USB滑杆，接著將USB接頭插入正在運行電腦的USB連接埠。
- 2 Windows：按一下[電腦] (或[我的電腦])，然後按兩下[IC RECORDER] → [FOR WINDOWS]。  
Mac：在桌面上按兩下[IC RECORDER]。
- 3 安裝說明指南。  
Windows：按兩下[Help\_Guide\_Installer] (或[Help\_Guide\_Installer.exe])。  
Mac：按兩下[Help\_Guide\_Installer\_for\_mac.app]。(v10.5.8或更高)  
按照出現在畫面中的指示進行安裝。
- 4 安裝完成後，在Windows的桌面上 (或Mac的Finder中) 按兩下[Help\_Guide\_icdp44\_zz.htm]圖示。您也可以以下Sony IC錄音機客戶支援首頁檢視說明指南：  
http://rd1.sony.net/help/icd/p44/zz/

將IC錄音機上的檔案複製到電腦

可以將IC錄音機上的檔案和資料夾複製到電腦上進行儲存。

- 1 把IC錄音機連接到電腦。
- 2 複製要傳輸到電腦上的檔案或資料夾。  
將想要複製的檔案或資料夾從“IC RECORDER”或“MEMORY CARD”拖放到電腦的本機磁碟上。  
複製檔案或資料夾 (拖放)  
IC RECORDER或 MEMORY CARD 電腦  
1 按住不放，  
2 拖曳，  
3 然後放下。
- 3 將IC錄音機自電腦中斷。

安裝Sound Organizer

在電腦上安裝Sound Organizer。

註

Sound Organizer僅與Windows PC相容，與Mac並不相容。

安裝Sound Organizer時，請登入具有系統管理員權限的帳戶。

- 1 滑動IC錄音機背面的USB滑杆，接著將USB接頭插入正在運行電腦的USB連接埠。  
如果IC錄音機無法直接連接電腦，請購買專用的USB連接線PC-U004，連接線作為維修零件販售。如需詳細資料，請向最近的Sony經銷商諮詢。  
您也可使用自行供電的USB集線器，只要具備USB標誌即可。

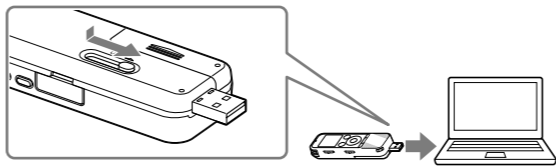

- 2 確認IC錄音機已經被正確辨識。  
把IC錄音機連接到電腦時，IC錄音機的顯示視窗將顯示“Connecting”。
- 3 前往[開始]功能表並按一下[電腦] (或[我的電腦])，然後按兩下[IC RECORDER] → [FOR WINDOWS]。
- 4 按兩下[SoundOrganizerInstaller\_V150] (或[SoundOrganizerInstaller\_V150.exe])。按照出現在畫面中的指示操作。
- 5 確定接受授權合約的條文之後，選擇[I accept the terms in the license agreement]，然後按一下[Next]。
- 6 當[Setup Type]視窗出現時，請選擇[Standard]或[Custom]，然後按一下[Next]。依照畫面上的指示進行，然後在選擇[Custom]時進行安裝設定。
- 7 當[Ready to Install the Program]視窗出現時，按一下[Install]。安裝開始。
- 8 當[Sound Organizer has been installed successfully.]視窗出現時，按一下[Launch Sound Organizer Now]，然後按一下[Finish]。

註

安裝Sound Organizer後，可能需要重新啟動電腦。

註

如果您將內建記憶體格式化，儲存的所有資料都會遭到清除。(說明指南和Sound Organizer軟體也會遭到清除。)

附加功能

說明指南附有這些額外錄音、播放及編輯等功能的詳細資訊。

- 場景選擇
- Recording Filter (錄音過濾器)
- Noise Cut (雜訊消除)
- T-MARK (曲目標記)
- DPC (Digital Pitch Control)
- A-B重播
- VOR (Voice Operated Recording)
- Easy Search (簡易搜尋)
- 分割
- Sound Organizer編輯軟體

事先注意事項

- 有關電源  
使用3.0 V或2.4 V操作IC錄音機。  
請使用兩顆LR03 (AAA型) 鹼性電池或NH-AAA充電電池。
- 有關安全  
駕車、騎車或操作任何機動車時不要操作IC錄音機。
- 有關握拿  
• 不要讓IC錄音機靠近熱源或放置於陽光直射、灰塵很多或有機械振動的地方。  
• 假如任何固體或液體落入本機，在進一步操作之前，請先取出電池並請合格的人員檢查。  
如果對IC錄音機有任何疑問或問題，請向最近的Sony經銷商諮詢。

警告

請勿將電池 (安裝的電池組或電池) 長時間暴露在過熱的熱源下，如陽光或火源等。

注意

若替換的電池類型不正確，則會有爆炸風險。請根據說明來丟棄使用過的電池。

防止聽覺損害

避免以高音量使用耳機。聽覺專家建議不要連續、高音量及長時間使用耳機。如果發生耳鳴現象，請調低音量或暫停使用。

僅適用於台灣



廢電池請回收

容量 (使用者可用容量\*1\*2)  
4 GB (約3.60 GB = 3865470566位元組)

\*1 檔案管理必須使用少量的內建記憶體，因此這些記憶體無法供使用者儲存之用。

\*2 在以IC錄音機將內建記憶體格式化的情況下。

電源需求

- 一節LR03 (AAA型) 鹼性電池 (附件)：1.5 V直流電
- 一節NH-AAA充電電池 (非附件)：1.2 V直流電

尺寸 (寬/高/深) (不包括突出部分和控制按鈕) (JEITA) \*3  
約37.2 mm × 113.2 mm × 19.3 mm

重量 (JEITA) \*3

約75 g包括兩顆LR03 (AAA型) 鹼性電池

\*3 依據JEITA (Japan Electronics and Information Technology Industries Association) 標準所測量的值。



ICD-PX440

## Welcome to your new Sony IC recorder!

This is the Quick Start Guide, which provides you with instructions on the basic operations of the IC recorder. Please read it carefully. We hope you enjoy using your new Sony IC recorder.

## Check the supplied items.

- IC Recorder (1)
- Stereo headphones\* (1)
- Carrying pouch\* (1)
- LR03 (size AAA) alkaline battery (2)
- Quick Start Guide
- Application Software, Sound Organizer (Installer file stored in the built-in memory so that you can install it to your computer.)
- Help Guide (HTML file stored in the built-in memory so it can easily be copied to your computer.)

\*supplied with some models in some regions.

### Optional accessories

- Electret condenser microphone ECM-TL3, ECM-CS3
- Rechargeable battery NH-AAA-B2EN, NH-AAA-B2KAN
- USB AC adaptor AC-U50AG
- Compact charger & 2-pc AAA Multi-Use Premium batteries BCG-34HS2KAN, BCG-34HW2KAN

### Note

Depending on the country or region, some of the models or optional accessories are not available.

## Parts and controls

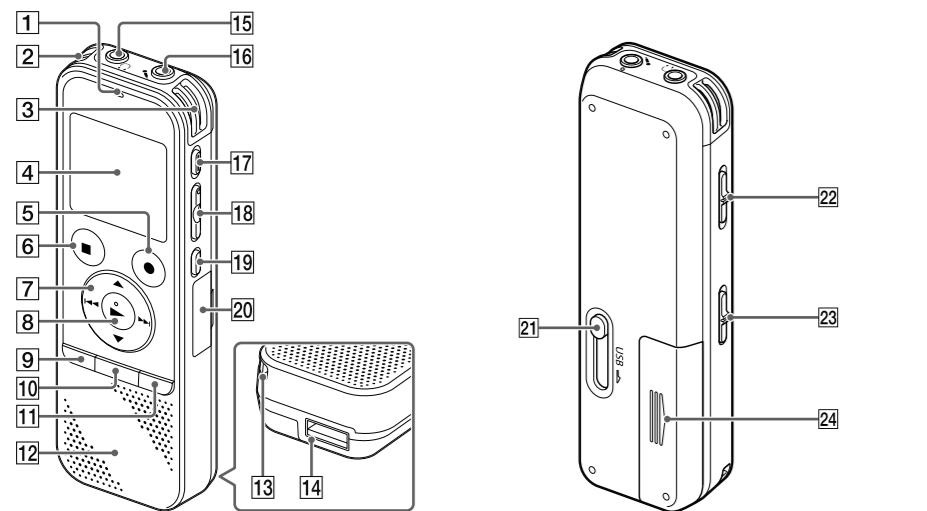

- |   |  |
|---|--|
| 1 Operation indicator   | 13 Strap hole (A strap is not supplied.)                           |
| 2 Built-in microphones (stereo) (L)   | 14 USB connector compartment                                       |
| 3 Built-in microphones (stereo) (R)   | 15 (headphones) jack   |
| 4 Display window  | 16 (microphone) (PLUG IN POWER) jack*1                             |
| 5 ●REC/PAUSE (record/pause) button  | 17 ERASE button  |
| 6 ■STOP button  | 18 VOL -/+ (volume -/+ ) button*1                                  |
| 7 Control button (▲, ▼, ◀, ▶) (review/fast backward), ▶▶ (cue/fast forward) | 19 A-B (repeat A-B) button   |
| 8 ▶▶(play/enter) button*1   | 20 M2™/microSD memory card slot (The card slot is in the cover.)*2 |
| 9 MENU button   | 21 USB slide lever   |
| 10 T-MARK (track mark) button   | 22 HOLD•POWER ON/OFF switch  |
| 11 FOLDER button  | 23 DPC (SPEED CTRL) switch   |
| 12 Speaker  | 24 Battery compartment   |

\*1 These buttons and the jack have a tactile dot. Use it as a reference point for operations, or to identify each terminal.

\*2 In this Quick Start Guide, M2™ and microSD cards are generally referred to as a "memory card." The M2™/microSD card slot is referred to as the "memory card slot."

## Let's try out your new IC recorder

### 1. Power on.

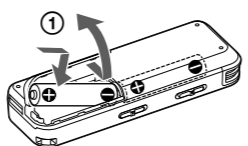

- Slide and lift the battery compartment lid, then insert LR03 (size AAA) alkaline batteries with the correct polarity.
- Turn the power on.  
To turn the power on Slide and hold the HOLD•POWER ON/OFF switch in the direction of "POWER ON/OFF" until the window display appears.

#### To prevent unintentional operations (HOLD)

Slide the HOLD•POWER ON/OFF switch in the direction of "HOLD."

- To release the IC recorder from the HOLD status, slide the HOLD•POWER ON/OFF switch towards the center.

### 2. Set the date and time.

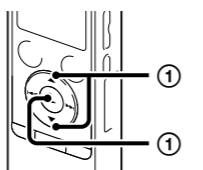

- Press ▲ or ▼ to set the year (the last two digits of the year), and then press ▶(play/enter). Repeat this procedure to set month, day, hour, and minute in sequence. When you set the minute and press ▶(play/enter), the clock reflects the setting.

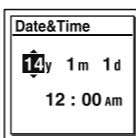

You can set the clock setting later. For details, refer to the Help Guide of the IC recorder.

### 3. Select the menu language.

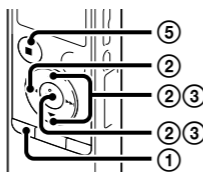

- Press MENU.
- Press ◀◀, press ▲ or ▼ to select and then press ▶(play/enter).
- Press ▲ or ▼ to select "Language," and then press ▶(play/enter).

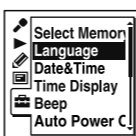

- Press ▲ or ▼ to select the language that you want to use in the display window, and then press ▶(play/enter).

You can select the following languages: (\* Default setting)

- for U.S.A and Latin American countries/regions English\*, Espanol (Spanish), Francais (French)
- for other countries/regions Deutsch (German), English\*, Español (Spanish), Français (French), Italiano (Italian), Русский (Russian), 한국어 (Korean), 繁體中文 (Chinese), 简体中文 (Chinese), ไทย (Thai)

- Press ■STOP.

### 4. Record.

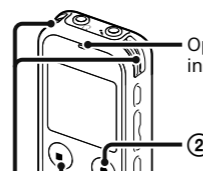

Before you start using the IC recorder, make sure that you slide the HOLD•POWER ON/OFF switch towards the center to release the HOLD status.

- Place the IC recorder so that the built-in microphones face the direction of the source to be recorded.
- Press ●REC/PAUSE. Recording starts and the operation indicator lights in red. You can pause recording by pressing ●REC/PAUSE. Press ●REC/PAUSE again to restart recording.
- Press ■STOP to stop recording. The "Accessing..." animation appears and the recording stops.

### 5. Listen.

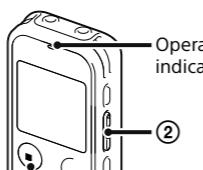

If you do not select a file, the file just recorded or played back most recently will be played back. For details of selecting a file, refer to the Help Guide of the IC recorder.

- Press ▶(play/enter). Playback starts and the operation indicator lights in green.
- Adjust the volume by pressing VOL -/+.
- Press ■STOP to stop playback.

### 6. Erase.

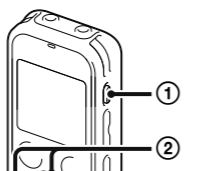

Once a file is erased, you cannot restore it.

- Press ERASE. "Erase?" is displayed and the file to be erased is played back for confirmation.
- Select "Execute" using ▲ or ▼, and then press ▶(play/enter). "Erasing..." is displayed while the selected file is being erased.

## Utilizing Your Computer

### Installing the help guide on your computer

By installing the help guide on your computer from the built-in memory of the IC recorder, you can search for detailed operations and possible solutions when a problem occurs.

- Slide the USB slide lever on the back of the IC recorder, and insert the USB connector into the USB port of a running computer.
- In Windows: Click [Computer] (or [My Computer]), then double-click [IC RECORDER] → [FOR WINDOWS]. In Mac: Double-click [IC RECORDER] on the desktop.
- Install the help guide. In Windows: Double-click [Help\_Guide\_Installer] (or [Help\_Guide\_Installer.exe]). In Mac: Double-click [Help\_Guide\_Installer\_for\_mac.app]. (v10.5.8 or higher) Follow the instructions that appear on the screen to proceed with installation.
- After the installation completes, double-click the [Help\_Guide\_icdp44\_zz.htm] icon in the desktop for Windows (or in Finder for Mac). The help guide is displayed. You can also view the help guide on the following Sony IC Recorder customer support home page: <http://rd1.sony.net/help/icd/p44/zz/>

### Copying files from the IC recorder to your computer

You can copy the files and folders from the IC recorder to your computer to store them.

- Connect the IC recorder to your computer.
- Copy files or folders you want to transfer to your computer. Drag and drop the files or folders you want to copy from "IC RECORDER" or "MEMORY CARD" to the local disk on your computer.

To copy a file or folder (Drag and drop)

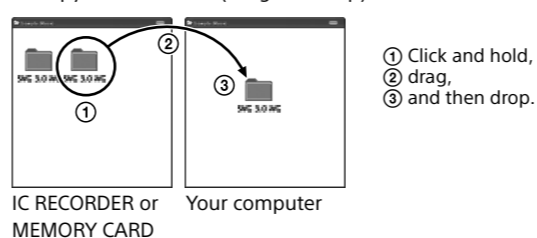

- Disconnect the IC recorder from your computer.

### Installing Sound Organizer

Install Sound Organizer on your computer.

#### Note

Sound Organizer is compatible with the Windows PC only. It is not compatible with Mac.

When installing Sound Organizer, log in to an account with administrator privileges.

- Slide the USB slide lever on the back of the IC recorder, and insert the USB connector into the USB port of a running computer. If the IC recorder cannot be connected to a computer directly, a dedicated USB connection support cable PC-U004 is available as a repair part for a fee. For more details, consult your nearest Sony dealer. You can also use a self-powered USB hub, provided it has a USB logo.

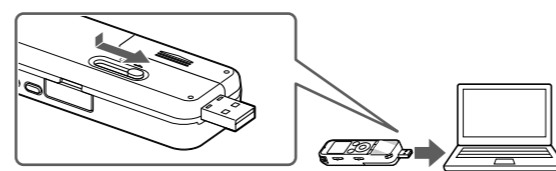

- Make sure the IC recorder has been recognized properly. While the IC recorder is connected to the computer, "Connecting" is displayed in the display window of the IC recorder.
- Go to the [Start] menu, click [Computer] (or [My Computer]), and then double-click [IC RECORDER] → [FOR WINDOWS].
- Double-click [SoundOrganizerInstaller\_V150] (or [SoundOrganizerInstaller\_V150.exe]). Follow the instructions that appear on the screen.
- Make sure that you accept the terms of the license agreement, select [I accept the terms in the license agreement], and then click [Next].
- When the [Setup Type] window appears, select [Standard] or [Custom], and then click [Next]. Follow the instructions on the screen and set the installation settings when you select [Custom].
- When the [Ready to Install the Program] window appears, click [Install]. The installation starts.
- When the [Sound Organizer has been installed successfully.] window appears, check [Launch Sound Organizer Now], and then click [Finish].

#### Note

You may need to restart your computer after installing Sound Organizer.

#### Note

If you format the built-in memory, all data stored there will be erased. (The Help Guide and the Sound Organizer software will also be erased.)

## Additional features

Details of these additional features for recording, playback, and editing are included in the help guide.

- Scene Selection
- Recording Filter
- Noise Cut
- T-MARK (Track mark)
- DPC (Digital Pitch Control)
- A-B Repeat
- VOR (Voice Operated Recording)
- Easy Search
- Divide
- Sound Organizer editing software

## Precautions

#### On power

Operate the IC recorder on 3.0 V or 2.4 V.

Use two LR03 (size AAA) alkaline batteries or NH-AAA rechargeable batteries.

#### On safety

Do not operate the IC recorder while driving, cycling or operating any motorized vehicle.

#### On handling

Do not leave the IC recorder in a location near heat sources, or in a place subject to direct sunlight, excessive dust or mechanical shock.

Should any solid object or liquid fall into the IC recorder, remove the battery and have the IC recorder checked by qualified personnel before operating it any further.

If you have any questions or problems concerning your IC recorder, please consult your nearest Sony dealer.

#### WARNING

Do not expose the batteries (battery pack or batteries installed) to excessive heat such as sunshine, fire or the like for a long time.

#### CAUTION

Risk of explosion if battery is replaced by an incorrect type. Dispose of used batteries according to the instructions.

#### Capacity (User available capacity\*1\*2)

4 GB (approx. 3.60 GB = 3,865,470,566 Byte)

\*1 A small amount of the built-in memory is used for file management and therefore not available for user storage.

\*2 When the built-in memory is formatted with the IC recorder.

#### Dimensions (w/h/d) (not incl. projecting parts and controls) (JEITA)\*3

Approx. 37.2 mm × 113.2 mm × 19.3 mm

#### Mass (JEITA)\*3

Approx. 75 g including two LR03 (size AAA) alkaline batteries

\*3 Measured value by the standard of JEITA (Japan Electronics and Information Technology Industries Association)