

**SONY**<sup>®</sup>

# Television

Reference Guide

**BRAVIA**

KD-70X8500B / 65X8500B / 55X8500B

# Table of Contents

Safety information	2
Precautions	4
Attaching the Table-Top Stand (Alternative)	6
Hiding the camera	7
Using the Remote Control	7
Displaying the Touchpad Operation Guide	7
Launching the Touchpad Tutorial	8
Connecting Other Devices	8
Installing the TV to the Wall	11
Troubleshooting	15
Troubles and Solutions	15
Specifications	16

## Introduction

Thank you for choosing this Sony product.  
Before operating the TV, please read this manual thoroughly and retain it for future reference.

### Note

- Before operating the TV, please read "Safety information" (page 2).
- Instructions about "Installing the TV to the Wall" are included within this TV's instructions manual.
- Images and illustrations used in Quick Start Guide and this manual are for reference only and may differ from actual product appearance.

## Location of the identification label

Labels for the Model No. and Power Supply rating (in accordance with applicable safety regulation) are located on the rear of the TV.

## Radio cautions sentence/ 無線電磁波法規

### 第十二條

經型式認證合格之低功率射頻電機，非經許可，公司、商號或使用者均不得擅自變更頻率、加大功率或變更原設計之特性及功能。

### 第十四條

低功率射頻電機之使用不得影響飛航安全及干擾合法通信；經發現有干擾現象時，應立即停用，並改善至無干擾時方得繼續使用。前項合法通信，指依電信法規定作業之無線電通信。低功率射頻電機須忍受合法通信或工業、科學及醫療用電波輻射性電機設備之干擾。

在 5.25-5.35 GHz 頻帶內操作之無線資訊傳輸設備，限於室內使用。

## Safety information

### WARNING

Batteries must not be exposed to excessive heat such as sunshine, fire or the like.

### Installation/Set-up

Install and use the TV set in accordance with the instructions below in order to avoid any risk of fire, electrical shock or damage and/or injuries.

#### Installation

- The TV set should be installed near an easily accessible AC power outlet (mains socket).
- Place the TV set on a stable, level surface to avoid it from falling down and cause personal injury or damage to the TV.
- Install the TV where it cannot be pulled, pushed, or knocked over.
- Install the TV so that the TV's Table-Top Stand does not protrudes out from the TV stand (not supplied).  
If the Table-Top Stand protrudes out from the TV stand, it may cause TV set to topple over, fall down, and cause personal injury or damage to the TV.

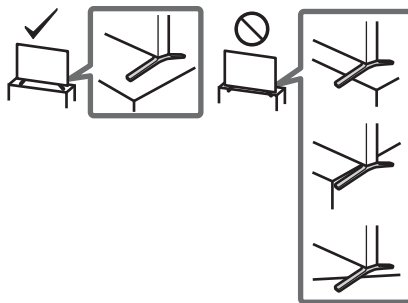

- Only qualified service personnel should carry out wall installations.

- For safety reasons, it is strongly recommended that you use Sony accessories, including:
  - Wall-Mount Bracket SU-WL450
- Be sure to use the screws supplied with the Wall-Mount Bracket when attaching the Wall-Mount Bracket to the TV set. The supplied screws are designed as indicated by illustration when measured from the attaching surface of the Wall-Mount Bracket. The diameter and length of the screws differ depending on the Wall-Mount Bracket model. Use of screws other than those supplied may result in internal damage to the TV set or cause it to fall, etc.

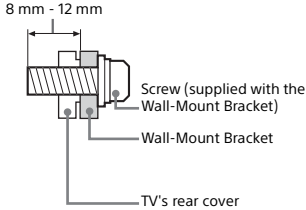

### Transporting

- Before transporting the TV set, disconnect all cables.
- Two or three people are needed to transport a large TV set.
- When transporting the TV set by hand, hold it as shown below. Do not put stress on the LCD panel and the frame around the screen.

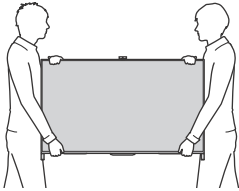

- When transporting the TV set, do not subject it to jolts or excessive vibration.
- When transporting the TV set for repairs or when moving, pack it using the original carton and packing material.

### Topple prevention

- Be sure to use strong cord that is capable of supporting the weight of the TV.

### Ventilation

- Never cover the ventilation holes or insert anything in the cabinet.
- Leave space around the TV set as shown below.
- It is strongly recommended that you use a Sony Wall-Mount Bracket in order to provide adequate air-circulation.

### Installed on the wall

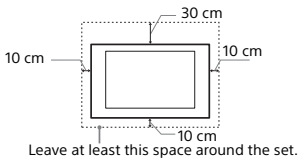

### Installed with stand

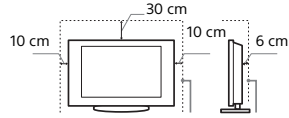

- To ensure proper ventilation and prevent the collection of dirt or dust:
  - Do not lay the TV set flat, install upside down, backwards, or sideways.
  - Do not place the TV set on a shelf, rug, bed or in a closet.
  - Do not cover the TV set with a cloth, such as curtains, or items such as newspapers, etc.
  - Do not install the TV set as shown below.

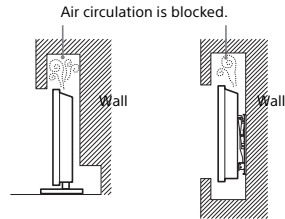

### AC power cord (mains lead)

Handle the AC power cord (mains lead) and outlet (mains socket) as follows in order to avoid any risk of fire, electrical shock or damage and/or injuries:

- Use only Sony supplied AC power cords (mains lead), not those of other brands.
- Insert the plug fully into the AC power outlet (mains socket).
- Operate the TV set on a 110 V AC supply only.
- When wiring cables, be sure to unplug the AC power cord (mains lead) for your safety and take care not to catch your feet on the cables.
- Disconnect the AC power cord (mains lead) from the AC power outlet (mains socket) before working on or moving the TV set.
- Keep the AC power cord (mains lead) away from heat sources.
- Unplug the AC power plug (mains plug) and clean it regularly. If the plug is covered with dust and it picks up moisture, its insulation may deteriorate, which could result in a fire.

### Note

- Do not use the supplied AC power cord (mains lead) on any other equipment.
- Do not pinch, bend, or twist the AC power cord (mains lead) excessively. The core conductors may be exposed or broken.
- Do not modify the AC power cord (mains lead).
- Do not put anything heavy on the AC power cord (mains lead).
- Do not pull on the AC power cord (mains lead) itself when disconnecting the AC power cord (mains lead).
- Do not connect too many appliances to the same AC power outlet (mains socket).
- Do not use a poor fitting AC power outlet (mains socket).

### Prohibited Usage

Do not install/use the TV set in locations, environments or situations such as those listed below, or the TV set may malfunction and cause a fire, electrical shock, damage and/or injuries.

## Location:

- Outdoors (in direct sunlight), at the seashore, on a ship or other vessel, inside a vehicle, in medical institutions, unstable locations, near water, rain, moisture or smoke.
- If the TV is placed in the changing room of a public bath or hot spring, the TV may be damaged by airborne sulfur, etc.



- For best picture quality, do not expose the screen to direct illumination or sunlight.
- Avoid moving the TV from a cold area to a warm area. Sudden room temperature changes may cause moisture condensation. This may cause the TV to show poor picture and/or poor colour. Should this occur, allow moisture to evaporate completely before powering the TV on.

## Environment:

- Places that are hot, humid, or excessively dusty; where insects may enter; where it might be exposed to mechanical vibration, near flammable objects (candles, etc). The TV set shall not be exposed to dripping or splashing and no objects filled with liquids, such as vases, shall be placed on the TV.
- Do not place the TV in a humid or dusty space, or in a room with oily smoke or steam (near cooking tables or humidifiers). Fire, electric shock, or warping may result.
- Do not install the TV in places subject to extreme temperature, such as in direct sunlight, near a radiator or a heating vent. The TV may overheat in such conditions which can cause deformation of the enclosure and/or TV malfunction.



## Situation:

- Do not use when your hands are wet, with the cabinet removed, or with attachments not recommended by the manufacturer. Disconnect the TV set from AC power outlet (mains socket) and antenna (aerial) during lightning storms.
- Do not install the TV so that it sticks out into an open space. Injury or damage from a person or object bumping into the TV may result.

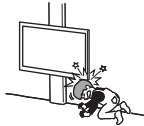

## Broken pieces:

- Do not throw anything at the TV set. The screen glass may break by the impact and cause serious injury.
- If the surface of the TV set cracks, do not touch it until you have unplugged the AC power cord (mains lead). Otherwise electric shock may result.

## When not in use

- If you will not be using the TV set for several days, the TV set should be disconnected from the AC power (mains) for environmental and safety reasons.
- As the TV set is not disconnected from the AC power (mains) when the TV set is just turned off, pull the plug from the AC power outlet (mains socket) to disconnect the TV set completely.
- However, some TV sets may have features that require the TV set to be left in standby to work correctly.

## For children

- Do not allow children to climb on the TV set.
- Keep small accessories out of the reach of children, so that they are not mistakenly swallowed.

## If the following problems occur...

**Turn off** the TV set and unplug the AC power cord (mains lead) immediately if any of the following problems occur. Ask your dealer or Sony service centre to have it checked by qualified service personnel.

### When:

- AC power cord (mains lead) is damaged.
- Poor fitting of AC power outlet (mains socket).
- TV set is damaged by being dropped, hit or having something thrown at it.
- Any liquid or solid object falls through openings in the cabinet.

## About LCD Monitor Temperature

When the LCD Monitor is used for an extended period, the panel surrounds become warm. You may feel hot when touching there by the hand.

## Precautions

### Viewing the TV

- Some people may experience discomfort (such as eye strain, fatigue, or nausea) while watching 3D video images or playing stereoscopic 3D games. Sony recommends that all viewers take regular breaks while watching 3D video images or playing stereoscopic 3D games. The length and frequency of necessary breaks will vary from person to person. You must decide what works best. If you experience any discomfort, you should stop watching the 3D video images or playing stereoscopic 3D games until the discomfort ends; consult a doctor if you believe necessary. You should also review (i) the instruction manual of any other device or media used with this television and (ii) our website (<http://www.sony-asia.com/support>) for the latest information. The vision of young children (especially those under six years old) is still under development. Consult your doctor (such as a pediatrician or eye doctor) before allowing young children to watch 3D video images or play stereoscopic 3D games. Adults should supervise young children to ensure they follow the recommendations listed above.
- Do not use, store, or leave the 3D Glasses or battery near a fire, or in places with a high temperature, e.g., in direct sunlight, or in sun-heated cars.
- When using the simulated 3D function, please note that the displayed image is modified from the original due to the conversion done by this television.
- View the TV in moderate light, as viewing the TV in poor light or during long period of time, strains your eyes.
- When using headphones, adjust the volume so as to avoid excessive levels, as hearing damage may result.

### LCD Screen

- Although the LCD screen is made with high-precision technology and 99.99% or more of the pixels are effective, black dots may appear or bright points of light (red, blue, or green) may appear constantly on the LCD screen. This is a structural property of the LCD screen and is not a malfunction.
- Do not push or scratch the front filter, or place objects on top of this TV set. The image may be uneven or the LCD screen may be damaged.
- If this TV set is used in a cold place, a smear may occur in the picture or the picture may become dark. This does not indicate a failure. These phenomena disappear as the temperature rises.
- Ghosting may occur when still pictures are displayed continuously. It may disappear after a few moments.
- The screen and cabinet get warm when this TV set is in use. This is not a malfunction.
- The LCD screen contains a small amount of liquid crystal. Follow your local ordinances and regulations for disposal.

## Handling and cleaning the screen surface/ cabinet of the TV set

Be sure to unplug the AC power cord (mains lead) connected to the TV set from AC power outlet (mains socket) before cleaning. To avoid material degradation or screen coating degradation, observe the following precautions.

- To remove dust from the screen surface/cabinet, wipe gently with a soft cloth. If dust is persistent, wipe with a soft cloth slightly moistened with a diluted mild detergent solution.
  - Never spray water or detergent directly on the TV set. It may drip to the bottom of the screen or exterior parts and enter the TV set, and may cause damage to the TV set.
- 
- Never use any type of abrasive pad, alkaline/acid cleaner, scouring powder, or volatile solvent, such as alcohol, benzene, thinner or insecticide. Using such materials or maintaining prolonged contact with rubber or vinyl materials may result in damage to the screen surface and cabinet material.
  - Periodic vacuuming of the ventilation openings is recommended to ensure proper ventilation.
  - Do not handle the speakers with excessive force during cleaning or maintenance to prevent any damages.

## Optional Equipment

Keep optional components or any equipment emitting electromagnetic radiation away from the TV set. Otherwise picture distortion and/or noisy sound may occur.

## Wireless Function of the unit

- Do not operate this unit near medical equipment (pacemaker, etc.), as malfunction of the medical equipment may result.
- Although this unit transmits/receives scrambled signals, be careful of unauthorised interception. We cannot be responsible for any trouble as a result.

## Recommendation of the F type plug

Projection of the inner wire from the connection part must be less than 1.5 mm.

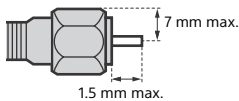

(Reference drawing of the F type plug)

## Caution about handling the remote control

- Observe the correct polarity when inserting batteries.
- Do not use different types of batteries together or mix old and new batteries.
- Dispose of batteries in an environmentally friendly way. Certain regions may regulate the disposal of batteries. Please consult your local authority.
- Handle the remote control with care. Do not drop or step on it, or spill liquid of any kind onto it.
- Do not place the remote control in a location near a heat source, a place subject to direct sunlight, or a damp room.

## 處理廢棄電池

為了保護我們的環境，請依當地法規之規定處理好廢棄電池。



廢電池請回收

GB

# Attaching the Table-Top Stand (Alternative)

You can change the Table-Top Stand from the edge to the middle position by referring to the instructions below.

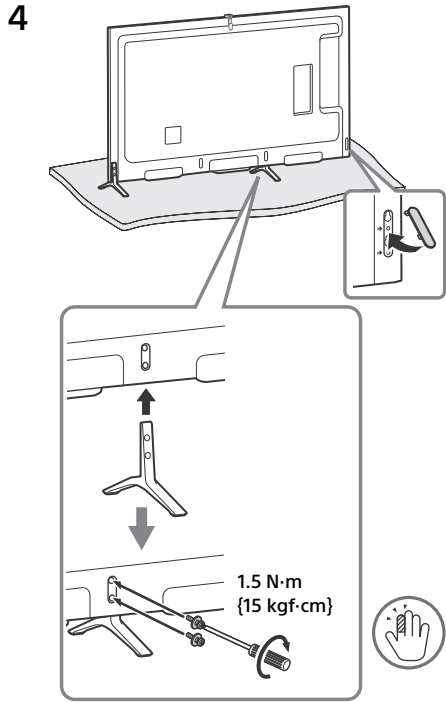
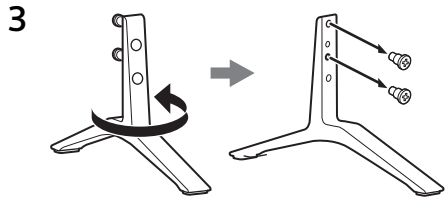
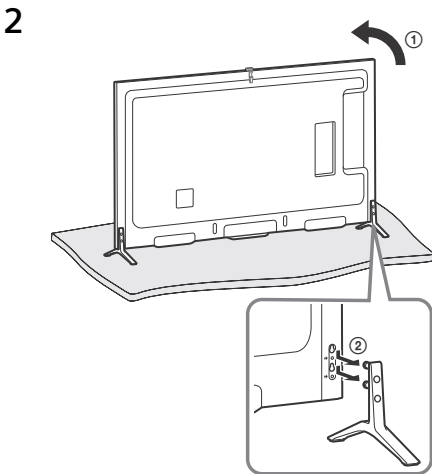
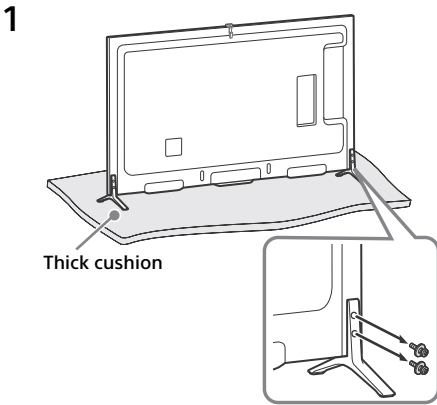
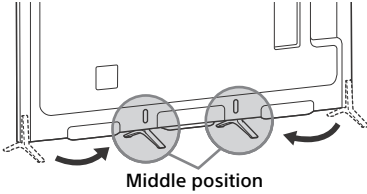

## 5 Repeat step 1-4 for the left side.

### Note

- Two or more people are needed to carry out this installation.
- Ensure that there are no objects in front of the TV.

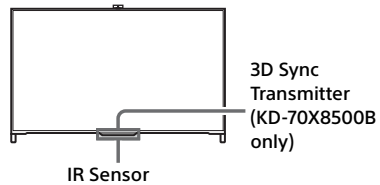

## To bundle the cables

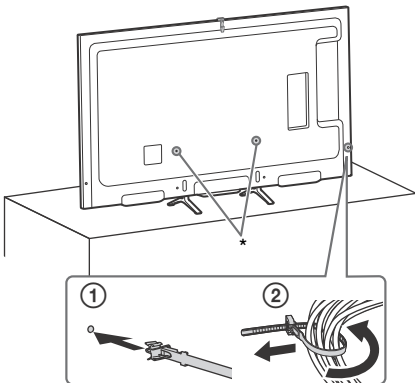
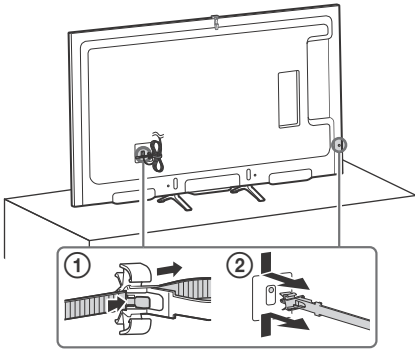

\* When the Table-top Stand is attached to middle position, you can choose either hole to attach the cable holder.

## Hiding the camera

If you do not wish to use the camera, hide it as illustrated.

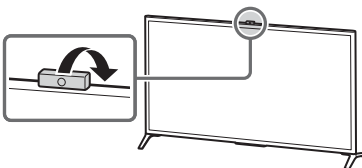

## Using the Remote Control

You can operate the TV by using the supplied Touchpad Remote Control or IR (infrared) Remote Control.

### Touchpad Remote Control



### IR Remote Control



### Note

- Touchpad Remote Control can only be used after registration with the TV. You can register the Touchpad Remote Control by pressing **HOME**, then select [Settings] → [System Settings] → [Touchpad Remote Control Setup].

## Displaying the Touchpad Operation Guide

Touchpad Operation Guide allows you to see the main gesture commands that are available for the current TV screen.

- 1 Touch and keep your finger on the centre of the touchpad to display the Touchpad Operation Guide.



## Launching the Touchpad Tutorial

1 Press **HOME**.



2 Slide to select **? [Help]**, then press the touchpad.

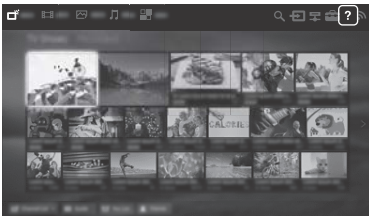

3 Slide up/down to select **[Touchpad Tutorial]**, then press the touchpad.

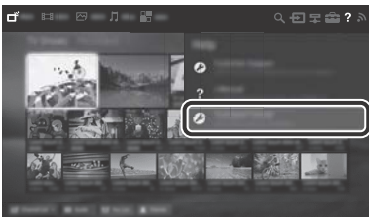

Follow the instructions on the screen.

### Note

- You can also launch the Touchpad Tutorial by pressing **HOME**, then select **[Settings]** → **[System Settings]** → **[Touchpad configurations]** → **[Start Tutorial]**.

## Connecting Other Devices

For more information on connections, refer to the i-Manual.

### Note

- Connect 4K devices (4K Media Player, 4K Set Top Box, etc.) to the HDMI IN 2 or HDMI IN 1 jack of the TV to enjoy copyright protected content.

### To connect with an HDMI cable

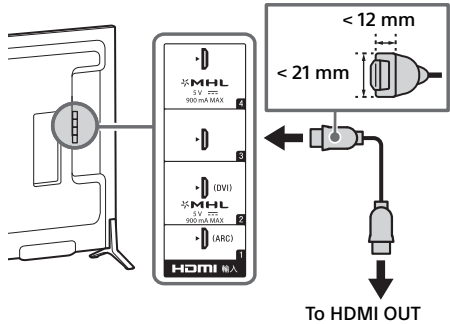

### To connect with component cables

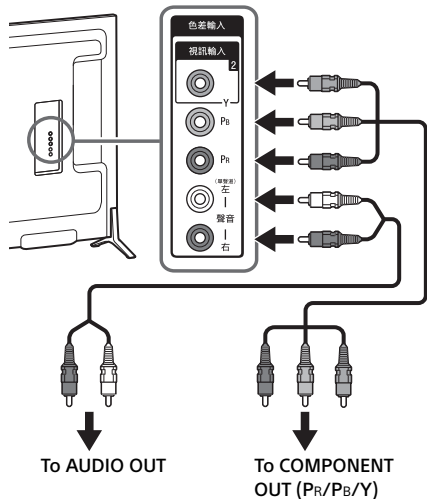



## To connect with AV composite cables

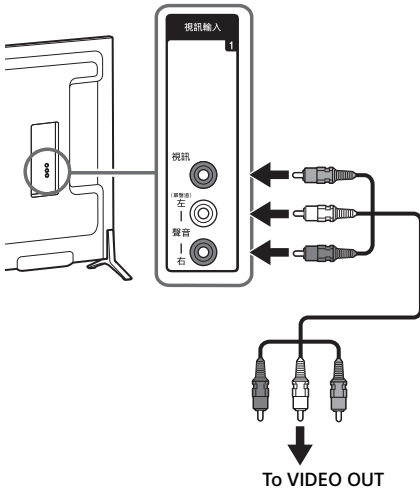

The TV simultaneously charges the MHL-compatible connected device while playing photo/music/video files. You can use the TV remote control to control the connected MHL-compatible device.

### Note

- If [Auto Input Change (MHL)] is set to [On], the TV automatically switches to HDMI IN 2/MHL or HDMI IN 4/MHL from other input when MHL-compatible device is connected to HDMI IN 2/MHL or HDMI IN 4/MHL jack. The availability of [Auto Input Change (MHL)] depends on whether the MHL-compatible device can support this feature.
- If [MHL Charging during Standby] is set to [On], you can continue charging the MHL-compatible device even when the TV is in standby mode.
- Connect the 4K smartphone or mobile devices to the HDMI IN 2/MHL jack.
- Use authorized MHL 3 CABLE with MHL logo for 4K smartphone or mobile devices.

GB

## To connect MHL Device

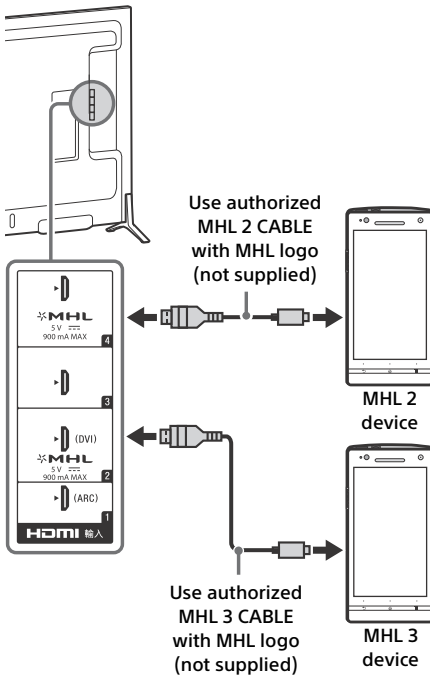

## Picture Quality

- AV composite cable
- Antenna (aerial) cable

- Component cable

- HDMI cable



Standard definition (SD) videos have picture signals with a vertical resolution of 480 (NTSC) or 576 (PAL/SECAM) lines.

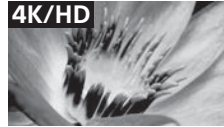

High definition (HD) videos have picture signals with a vertical resolution of 720 or 1080 lines.  
(For 4K vertical resolution: 2160 lines)

# Installing the TV to the Wall

This TV's instruction manual only shows the steps on preparing the installation of the TV before installing to the wall.

## To Customers:

For product protection and safety reasons, Sony strongly recommends that installation of your TV be performed by Sony dealers or licensed contractors. Do not attempt to install it yourself.

## To Sony Dealers and Contractors:

Provide full attention to safety during the installation, periodic maintenance and examination of this product.

GB

Sufficient expertise is required for installing this product, especially to determine the strength of the wall for withstanding the TV's weight. Be sure to entrust the attachment of this product to the wall to Sony dealers or licensed contractors and pay adequate attention to safety during the installation. Sony is not liable for any damage or injury caused by mishandling or improper installation.

Use the Wall-Mount Bracket SU-WL450 (not supplied) to install the TV to the wall. When installing the Wall-Mount Bracket, also refer to the Operating Instructions and Installation Guide supplied with the Wall-Mount Bracket.

### Note

- Be sure to store the removed screws in a safe place, keeping them away from children.

## 1 Remove the screws from the rear of the TV.

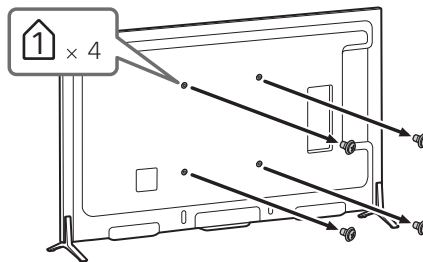

- 2 Make sure that the wall has enough space for the TV and is capable of supporting a weight of at least four times that of the TV. Refer to the following table on installing the TV to the wall. See page 16-18 (Specifications) for the TV's weight.

**KD-70X8500B**

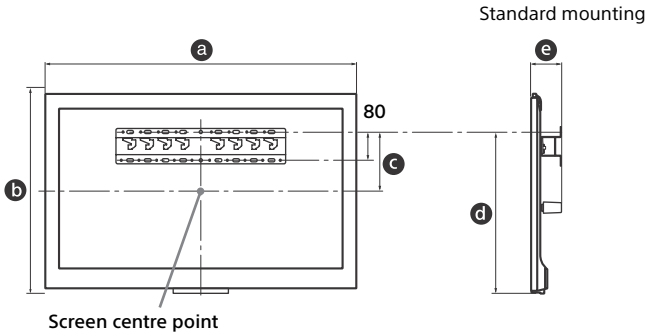

**except KD-70X8500B**

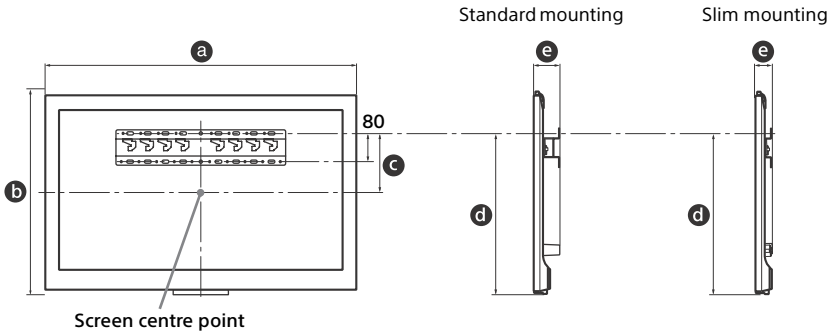

Unit: mm

Model Name	Display dimensions		Screen centre dimension	Length for mounting		
	a	b	c	d	e	
KD-					Standard mounting	Slim mounting
70X8500B	1,572	938	147	616	109	-
65X8500B	1,448	865	171	605	113	72
55X8500B	1,232	741	171	543	113	72

**Note**

- Figures in the table may differ slightly depending on the installation.

### 3 Attach the Attachment parts for Wall-Mount Bracket. Check the Attachment parts by referring to "1" of the Wall-Mount Bracket Installation Guide.

#### Note

- If using an electric screwdriver, set the torque at approximately 1.5 N·m (15 kgf·cm).
- Be sure to store the unused parts in a safe place for future use. Retain this manual for future reference.

#### Standard mounting

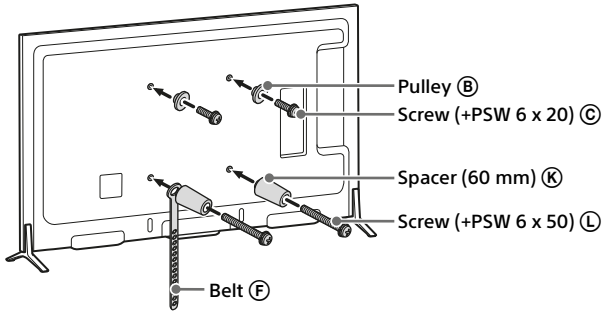

#### Slim mounting (except KD-70X8500B)

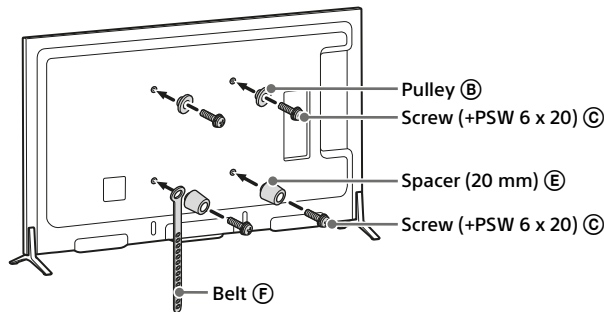

### 4 Connect necessary cables to the TV.

#### Note

- You cannot access to any terminal after installing the TV to the wall.

### 5 Detach the Table-Top Stand from the TV.

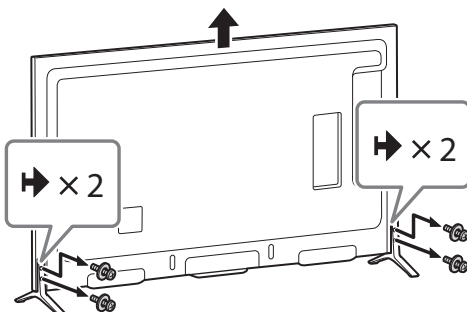

## 6 Attach the stand cover.

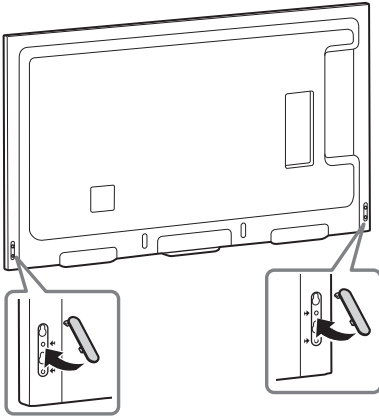

## 7 Install the TV to the Base. Refer to "5" of Installation Guide and "Installing the TV to the Wall" of Operating Instructions supplied with the Wall-Mount Bracket.

Model Name KD-	Hook location
70X8500B/ 65X8500B	a
55X8500B	b

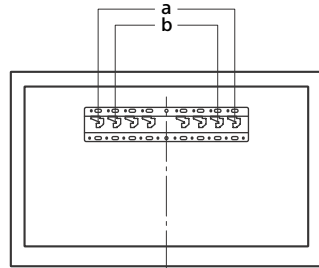

Refer to the instructions supplied with the Wall-Mount Bracket for your model to install the TV on the wall.

## Troubleshooting

**When the illumination LED is flashing in red, count how many times it flashes (interval time is three seconds).**

If the illumination LED flashes red, reset the TV by disconnecting the AC power cord (mains lead) from the TV for two minutes, then turn on the TV.

If the problem persists, contact your dealer or Sony service centre with the number of times the Illumination LED flashes red (interval time is three seconds). Press I/⏻ on the TV to turn it off, disconnect the AC power cord (mains lead), and inform your dealer or Sony service centre.

**When the illumination LED is not flashing, check the items as follows.**

You can also refer to [Troubleshooting] in the i-Manual or perform self-diagnosis by selecting ? [Help] → [Customer Support] → [Self Diagnostics]. If the problem persists, have your TV serviced by qualified service personnel.

### Troubles and Solutions

**There is no picture (screen is dark) and no sound.**

- Check the antenna (aerial)/cable connection.
- Connect the TV to the AC power (mains), and press I/⏻ ( 電源 ) on the TV 電視電源 or remote control.

**Some programmes cannot be tuned.**

- Check the antenna (aerial).

**The remote control does not function.**

- Replace the batteries.
- Your TV may be in SYNC mode. Press Control Bar (...) and slide left/right to select [SYNC MENU] then press the touchpad. Select [TV Control] and then select [Home (Menu)] or [Options] to control the TV. When using IR Remote Control, press SYNC MENU, select [TV Control] and then select [Home (Menu)] or [Options] to control the TV.

**The [Parental Lock] password has been forgotten.**

- Enter 9999 for the PIN code. (PIN code 9999 is always accepted.)

**The TV surrounds become warm.**

- When the TV is used for an extended period, the TV surrounds become warm.  
You may feel hot when touching there by the hand.

**Frozen audio or video, a blank screen, or the TV does not respond to TV or remote control buttons.**

- Perform a simple reset of the TV by unplugging the AC power cord (mains lead) for two minutes, then plug it in again.

**The I/⏻, CH+/-, ⏪ +/-, ⏩ +/-, ⏮, ⏭ and HOME buttons cannot be located on the TV.**

- See below illustration for location of the buttons on the TV.

Rear of TV

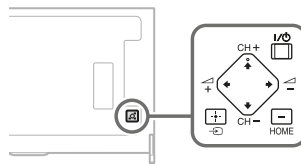

- The illumination LED is turned on.
- If you do not wish to light up the illumination LED, you can turn it off.  
Press **HOME**, then select [Settings] → [System Settings] → [General Set-up] → [Illumination LED] → [Off]. You can also press **OPTIONS**, then select [Illumination LED] → [Off].

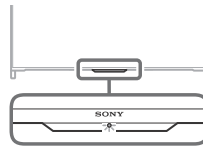

**Cannot connect to a wireless router by WPS.**

- If you use WEP security, select [Easy] → [Wi-Fi] → [Connect by scan list]. Then, select the network name (SSID) you want to connect.

**Cannot find the required network name in network setup.**

- Select [[Manual Entry]] and press ⊕ to enter network name.

# Specifications

## System

### Panel system

LCD (Liquid Crystal Display) Panel, LED Backlight

### TV system

Analogue: M

Digital: DVB-T

### Colour/video system

Analogue: PAL (Video only), SECAM (Video only), NTSC3.58, NTSC4.43 (Video only)

Digital: Refer to the i-Manual

### Channel coverage

Analogue: VHF: 2-13/UHF: 14-69/CATV: 1-135

Digital: VHF: 2-13/UHF: 14-69

### Sound output

10 W + 10 W

### Wireless technology

Protocol IEEE802.11a/b/g/n

## Input/Output jacks

### Antenna (aerial)/cable

75 ohm external terminal for VHF/UHF and CATV

### VIDEO IN 1

Video/Audio input (phono jacks)

### COMPONENT IN

YPbPr (Component Video): 1080p (60 Hz),

1080i (60 Hz), 720p (60 Hz), 480p, 480i

Audio input (phono jacks)

### VIDEO IN 2

Video input (common phono pin with Y input)

### HDMI IN 1,2,3,4 (Support 4K resolution)

Video (2D): 4096 × 2160p (60 Hz)\*, 4096 × 2160p (24 Hz), 3840 × 2160p (60 Hz)\*, 3840 × 2160p (24, 25, 30 Hz), 1080p (30, 60 Hz), 1080/24p, 1080i (60 Hz), 720p (30, 60 Hz), 720/24p, 480p, 480i, PC Formats

\*YCbCr 4:2:0 / 8 bit

Video (3D):

Frame Packing\*: 1080p (30 Hz), 1080/24p,

1080i (60 Hz), 720p (30, 60 Hz), 720/24p

Side-by-Side: 1080p (60 Hz), 1080/24p,

1080i (60 Hz), 720p (60 Hz)

Over-Under: 1080p (30, 60 Hz), 1080/24p,

1080i (60 Hz), 720p (60 Hz)

Audio: 5.1 channel linear PCM: 32, 44.1 and

48 kHz, 16, 20 and 24 bits, Dolby Digital

ARC (Audio Return Channel) (HDMI IN 1 only)

### MHL (common with HDMI IN 2/4)

Video (2D): 4096 × 2160p (24 Hz)\*, 3840 × 2160p (24, 25, 30 Hz)\*, 1080p (60 Hz)\*, 1080p (30 Hz), 1080/24p, 1080i (60 Hz), 720p (30, 60 Hz), 720/24p, 480p, 480i

\* HDMI IN 2 only

Video (3D):

Frame Packing\*: 1080p (30 Hz), 1080/24p, 1080i (60 Hz), 720p (30, 60 Hz), 720/24p

Side-by-Side: 1080p (60 Hz)\*, 1080/24p, 1080i (60 Hz), 720p (60 Hz)

Over-Under: 1080p (60Hz)\*, 1080p (30 Hz), 1080/24p, 1080i (60 Hz), 720p (60 Hz)

\* HDMI IN 2 only

Audio: 5.1 channel linear PCM: 32, 44.1 and 48 kHz, 16, 20 and 24 bits, Dolby Digital

### DIGITAL AUDIO OUT (OPTICAL)

Digital optical jack (Two channel linear PCM, Dolby Digital)

### HDMI 2 AUDIO IN

Analogue audio input (stereo mini jack)

### AUDIO OUT/

Audio output (stereo mini jack)

Headphone jack

(supports Subwoofer out)

### ψ1, ψ2, ψ3

USB port

### LAN

10BASE-T/100BASE-TX connector (Depending on the operating environment of the network, connection speed may differ. 10BASE-T/100BASE-TX communication rate and communication quality are not guaranteed for this TV.)

## Others

### Optional accessories

Wall-Mount Bracket: SU-WL450

Wireless subwoofer: SWF-BR100

Active 3D Glasses: TDG-BT500A (KD-70X8500B)



Passive 3D Glasses: TDG-500P (KD-65X8500B/55X8500B)



### Operating temperature

0 °C – 40 °C

### Operating humidity

10 % – 80 % RH (non-condensing)



## Power and others

### Power requirements

Rating: Input 110 V AC, 60 Hz

### Screen size (measured diagonally) (Approx.)

KD-70X8500B: 70 inches / 176.6 cm

KD-65X8500B: 65 inches / 163.9 cm

KD-55X8500B: 55 inches / 138.8 cm

### Display resolution

3,840 dots (horizontal) × 2,160 lines (vertical)

### Power consumption

KD-70X8500B: 305 W

KD-65X8500B: 285 W

KD-55X8500B: 257 W

### Standby power consumption\*

KD-70X8500B: 0.2 W

KD-65X8500B: 0.2 W

KD-55X8500B: 0.2 W

### Output Rating

USB 1, 3: 5 V, 500 mA MAX

USB 2: 5 V, 800 mA MAX

MHL (HDMI IN 2, 4): 5 V, 900 mA MAX

## Dimensions (Approx.) (w × h × d)

### with Table-Top Stand

KD-70X8500B: 1,572 × 983 × 364 mm

KD-65X8500B: 1,448 × 910 × 285 mm

KD-55X8500B: 1,232 × 785 × 285 mm

### without Table-Top Stand

KD-70X8500B: 1,572 × 938 × 75 mm

KD-65X8500B: 1,448 × 865 × 66 mm

KD-55X8500B: 1,232 × 741 × 66 mm

## Stand width (Approx.)

### Edge position:

KD-70X8500B: 1,572 mm

KD-65X8500B: 1,448 mm

KD-55X8500B: 1,232 mm

### Middle position:

KD-70X8500B: 431 mm

KD-65X8500B: 431 mm

KD-55X8500B: 431 mm

## Mass (Approx.)

### with Table-Top Stand

KD-70X8500B: 44.0 kg

KD-65X8500B: 33.3 kg

KD-55X8500B: 24.1 kg

### without Table-Top Stand

KD-70X8500B: 43.0 kg

KD-65X8500B: 32.7 kg

KD-55X8500B: 23.5 kg

\* Specified standby power is reached after the TV finishes necessary internal processes.

## Note

- Optional accessories availability depends on countries/region/TV model/stock.
- Design and specifications are subject to change without notice.
- This TV set incorporates MHL 2 for HDMI IN 4/MHL and MHL 3 for HDMI IN 2/MHL.

## Trademark information

- The terms HDMI and HDMI High-Definition Multimedia Interface, and the HDMI Logo are trademarks or registered trademarks of HDMI Licensing LLC in the United States and other countries.
- DLNA®, the DLNA Logo and DLNA CERTIFIED® are trademarks, service marks, or certification marks of the Digital Living Network Alliance.
- Manufactured under license from Dolby Laboratories. Dolby and the double-D symbol are trademarks of Dolby Laboratories.
- "BRAVIA" and BRAVIA are trademarks of Sony Corporation.
- TrackID is a trademark or registered trademark of Sony Mobile Communications AB.
- Gracenote, Gracenote eyeQ, Gracenote VideoID, Gracenote Video Explore, Gracenote MusicID, the Gracenote logo and logotype, and the "Powered by Gracenote" logo are either registered trademarks or trademarks of Gracenote in the United States and/or other countries.
- Opera® Devices SDK from Opera Software ASA. Copyright 1995-2014 Opera Software ASA. All rights reserved.
- Wi-Fi, Wi-Fi Direct and Miracast are trademarks or registered trademarks of Wi-Fi Alliance.
- "Sony Entertainment Network logo" and "Sony Entertainment Network" are trademarks of Sony Corporation.
- MHL, Mobile High-Definition Link and the MHL Logo are trademarks or registered trademarks of MHL Licensing, LLC.
- For DTS patents, see <http://patents.dts.com>. Manufactured under license from DTS Licensing Limited. DTS, the Symbol, & DTS and the Symbol together are registered trademarks, and DTS Digital Surround is a trademark of DTS, Inc. © DTS, Inc. All Rights Reserved.

- Designed with UEI Technology™  
Under License from Universal Electronics Inc. Portions © UEI 2000 – 2013
- The Bluetooth® word mark and logos are owned by the Bluetooth SIG, Inc. and any use of such marks by Sony Corporation is under license. Other trademarks and trade names are those of their respective owners.
- ©2014 RealNetworks, Inc. Patents Pending. All rights reserved. RealNetworks logo is a trademark of RealNetworks, Inc.
- The N Mark is a trademark or registered trademark of NFC Forum, Inc. in the United States and in other countries.





產品名稱： 電視  
型號： KD-70X8500B  
KD-65X8500B  
KD-55X8500B



廢電池請回收

額定電壓： 110 V ~  
額定頻率： 60 Hz  
消耗功率： KD-70X8500B: 305 W  
KD-65X8500B: 285 W  
KD-55X8500B: 257 W



製造年份： 如機體上標示  
機器號碼： 如機體上標示  
生產國別： 日本  
製造廠商： Sony EMCS Corporation  
進口商： 台灣索尼股份有限公司  
地址： 台北市長春路 145 號 5 樓

Sony 客服中心

客服諮詢電話： 4499111 (行動電話撥打請加 02)

海外來電請撥： 886-2-77140021

服務網頁 <http://www.sony.com.tw/service/>



Customer Support and Contact:

<http://www.sony-asia.com/support>

<http://www.sony.net/>

©2014 Sony Corporation Printed in Japan

4-534-216-E1(1)